



Communication Systems II

Noise

Narrow-Band Noise

Envelope of NBN



Noise

- Unwanted signal that tend to disturb the transmission and processing of signals in communication systems.
- Thermal Noise → random motion of electrons in a conductor.
- Shot noise → arises in electronic devices, sudden change in voltage or current.



White Noise

- White → occupies all frequencies → PSD is independent on the operating frequency
- Dimensions of N_o is watt per Hertz, $N_o = KT$

$$S_N(f) = \frac{N_o}{2}$$

$$R_N(\tau) = \frac{N_o}{2} \delta(\tau)$$

- Any two different samples of white noise no matter how close they are will be uncorrelated.
- If white noise is Gaussian then they will also be independent

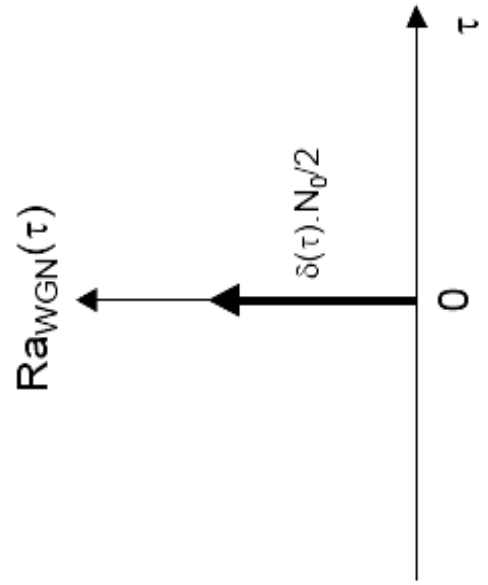
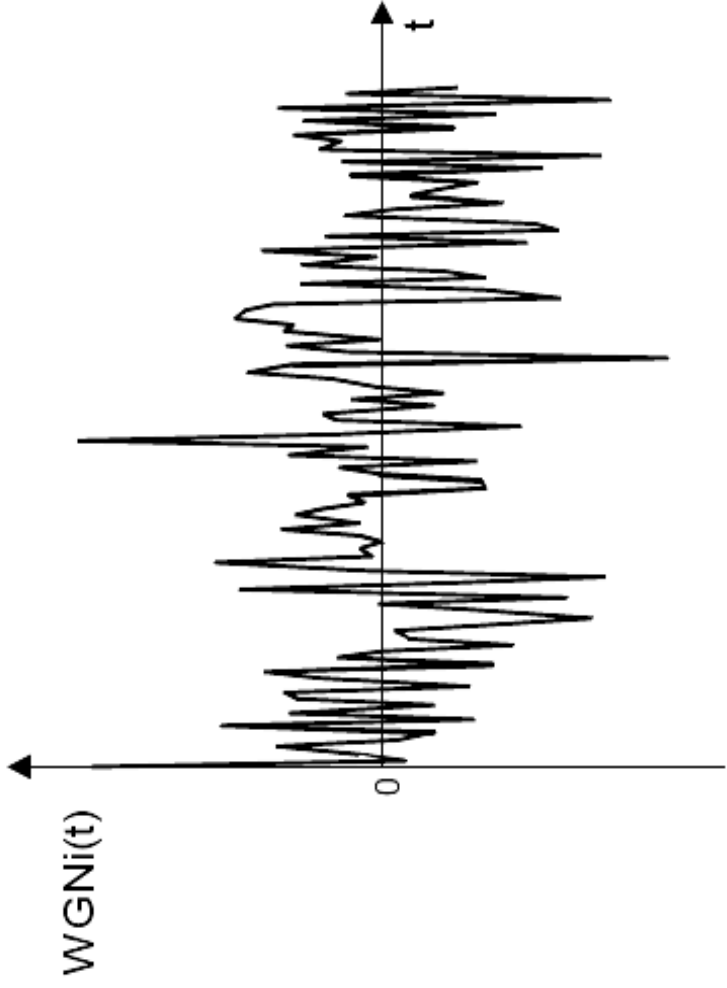
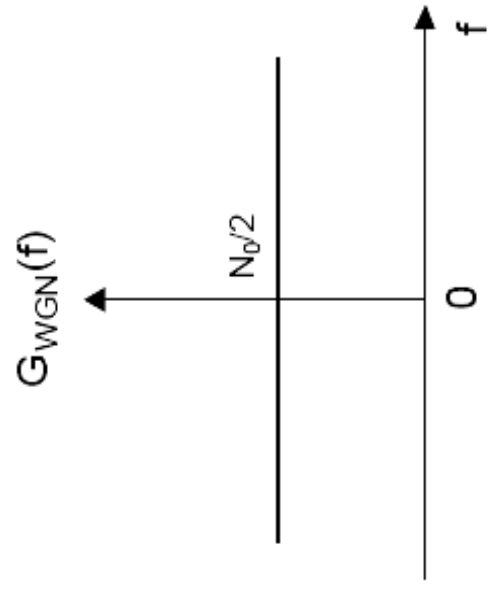
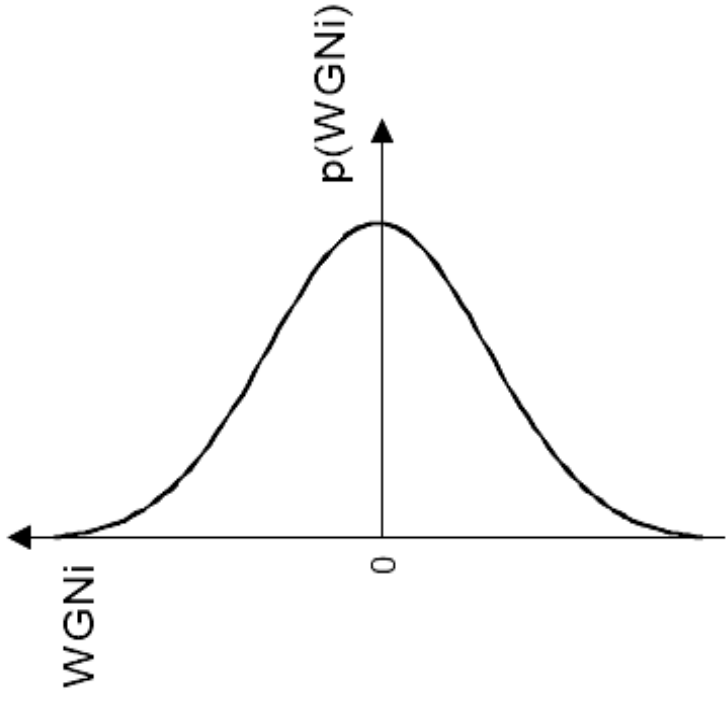



Ideal low pass filtered white noise

- A white Gaussian noise with zero mean and variance $N_0/2$ is applied to an ideal low pass filter of bandwidth B and amplitude response of one.
- PSD of output $Y(t)$ is

$$S_Y(f) = \begin{cases} \frac{N_0}{2} & -B \leq f \leq B \\ 0 & \text{otherwise} \end{cases}$$

- The autocorrelation is $R_Y(\tau) = N_0 B \text{sinc}(2B\tau)$
- Autocorrelation maximum at τ equal zero equal $N_0 B$ and passes through zero at $\tau = n/2B$ for $n =$ integer values and variance $N_0 B$
- If noise is samples at rate $2B$ then they are uncorrelated and being Gaussian then statistically independent



RC low pass filtered white noise

- The $H(f)$ of RC filter is $H(f) = \frac{1}{1 + j2\pi fRC}$
- The PSD of the o/p is $S_Y(f) = \frac{N_o / 2}{1 + (2\pi fRC)^2}$
- The autocorrelation of the output is $R_Y(\tau) = \frac{N_o}{4RC} \exp\left(-\frac{|\tau|}{RC}\right)$
- If noise is samples at rate $0.217/RC$ then they are uncorrelated and being Gaussian then statistically independent



Ex sine wave plus white noise

$$X(t) = A \cos(2\pi f_c t + \theta) + N(t)$$

θ is Uniformly distributed, $N(t)$ is WGN

$$R_X(\tau) = E[X(t)X(t+\tau)] = \frac{A^2}{2} \cos(2\pi f_c \tau) + \frac{N_0}{2} \delta(\tau)$$

$$S_X(f) = \frac{A^2}{4} [\delta(f - f_c) + \delta(f + f_c)] + \frac{N_0}{2}$$

Noise Equivalent Bandwidth

- Output average power of ILPF $\rightarrow N_o B = (N_o/2) * 2B$
- Output average power of RCLPF $\rightarrow N_o/4RC$
- Output average power of with gain ILPF $\rightarrow N_o B H^2(0)$
- Output average of any LPF with gain $\rightarrow N = N_o \int_0^{\infty} |H(f)|^2 df$

■ Equivalent Bandwidth =
$$B = \frac{\int_0^{\infty} |H(f)|^2 df}{H^2(0)}$$

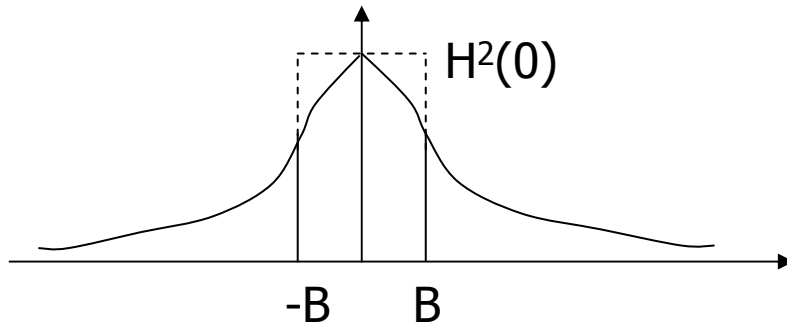



Narrow Band Noise

- Filters at the receiver have enough bandwidth to pass the desired signal but not too big to pass excess noise.
- Narrow band \rightarrow center frequency is much bigger than the bandwidth.
- Noise at the output of such filters are called NBN.
- NBN has spectral concentrated about some mid-band frequency $\pm f_c$
- The sample function of such NBN $n(t)$ appears as a sinusoidal wave of frequency f_c which modulates slowly in amplitude and phase.

$$S_N(f) = \frac{N_o}{2} |H(f)|^2$$

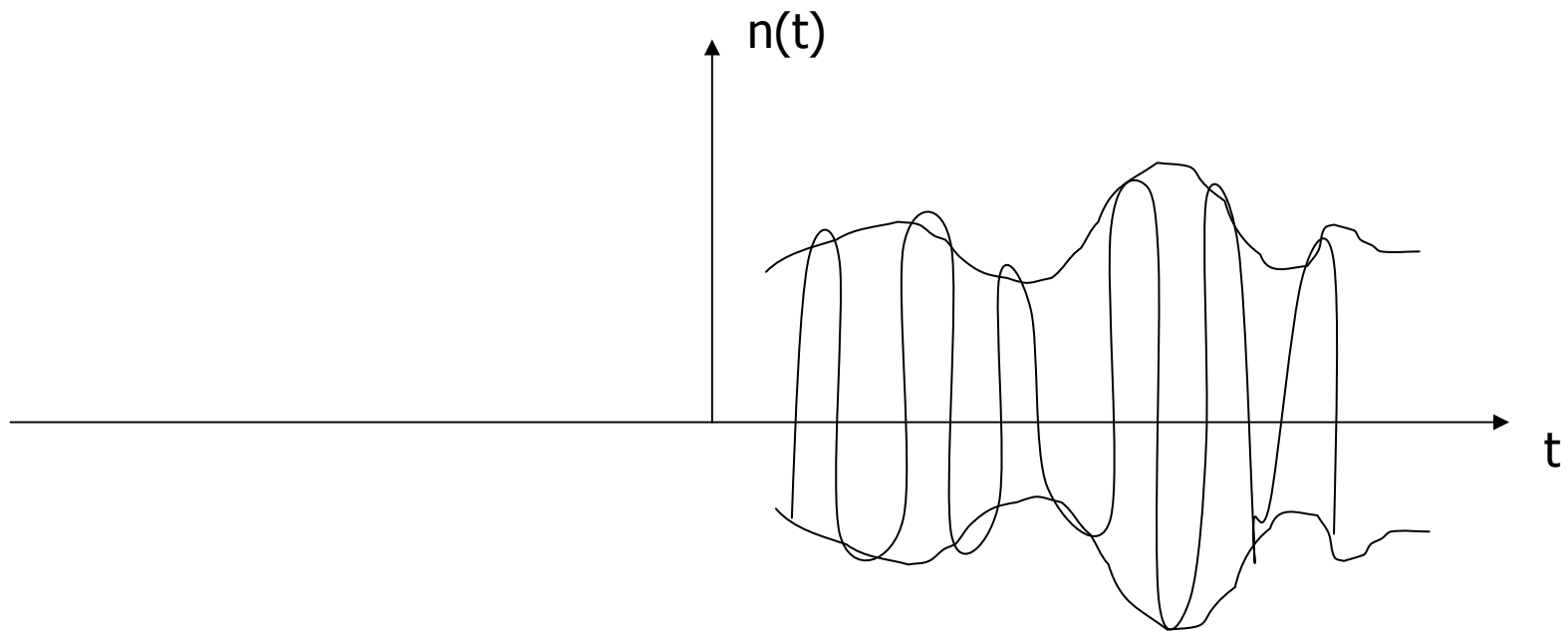
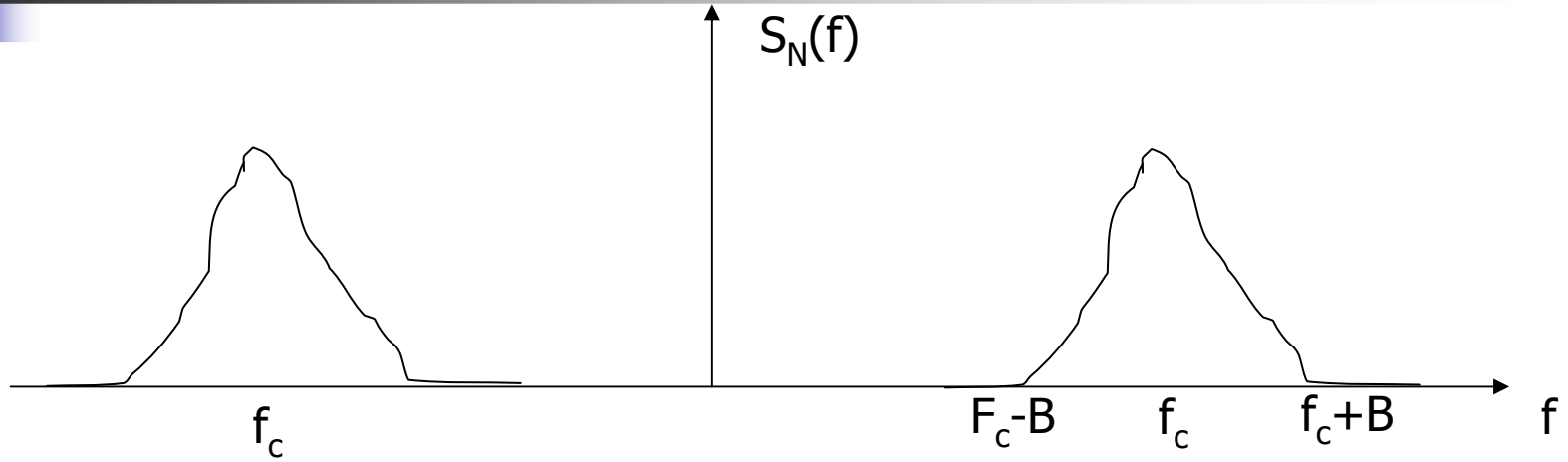
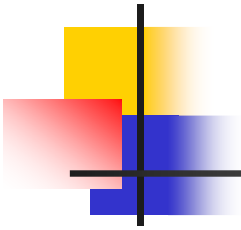



Representation of NBN

- $n(t)$ can be represented by its pre-envelope and complex envelope as follows

$$n_+(t) = n(t) + j\hat{n}(t)$$

$$\tilde{n}(t) = n_+(t) \exp(-j2\pi f_c t)$$

$$\tilde{n}(t) = n_c(t) + jn_s(t)$$

In phase comp. of NBN $n_c(t) = n(t) \cos(2\pi f_c t) + \hat{n}(t) \sin(2\pi f_c t)$

Quadrature comp. of NBN $n_s(t) = \hat{n}(t) \cos(2\pi f_c t) - n(t) \sin(2\pi f_c t)$

\therefore

$$n(t) = n_c(t) \cos(2\pi f_c t) - n_s(t) \sin(2\pi f_c t)$$



Properties of Inphase and Quadrature components of NBN

1. If $n(t)$ is zero mean then $n_c(t)$ and $n_s(t)$ are also zero mean
2. If $n(t)$ is G. RP then $n_c(t)$ and $n_s(t)$ are jointly G. RP
3. If $n(t)$ is WSS then $n_c(t)$ and $n_s(t)$ are jointly WSS

$$R_{n_c}(\tau) = R_{n_s}(\tau) = R_N(\tau) \cos(2\pi f_c \tau) + \hat{R}_N(\tau) \sin(2\pi f_c \tau)$$

crosscorrelation

$$R_{n_c n_s}(\tau) = -R_{n_s n_c}(\tau) = R_N(\tau) \sin(2\pi f_c \tau) - \hat{R}_N(\tau) \cos(2\pi f_c \tau)$$



Properties of inphase and quadrature components of NBN

4. PSD of inphase and quadrature components are the same and are related to the PSD of the original NBN PSD as follows

$$S_{n_c}(f) = S_{n_s}(f) = \begin{cases} S_n(f - f_c) + S_n(f + f_c), & -B \leq f \leq B \\ 0 & \textit{otherwise} \end{cases}$$

5. If $n(t)$ is zero mean then $n_c(t)$ and $n_s(t)$ will have the same variance as $n(t)$ itself
6. If $n(t)$ is zero mean Gaussian with symmetric PSD around f_c , then $n_c(t)$ and $n_s(t)$ are statistically independent
7. Cross spectral density

$$S_{n_c n_s}(f) = -S_{n_s n_c}(f) = \begin{cases} j[S_n(f + f_c) - S_n(f - f_c)] & -B \leq f \leq B \\ 0 & \textit{otherwise} \end{cases}$$

Ideal BPF white noise

- Consider a WGN of zero mean and PSD $N_0/2$ which passes by an IBPF of unit amplitude response and BW $2B$.
- The PSD of the filtered noise $n(t)$ has the same shape of the BPF

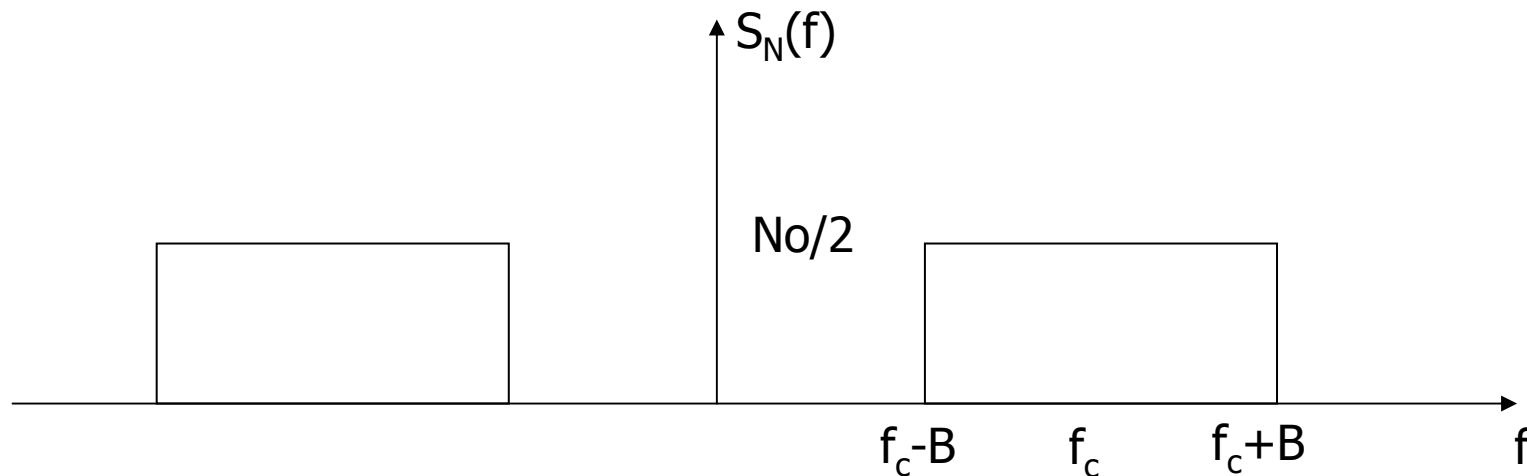

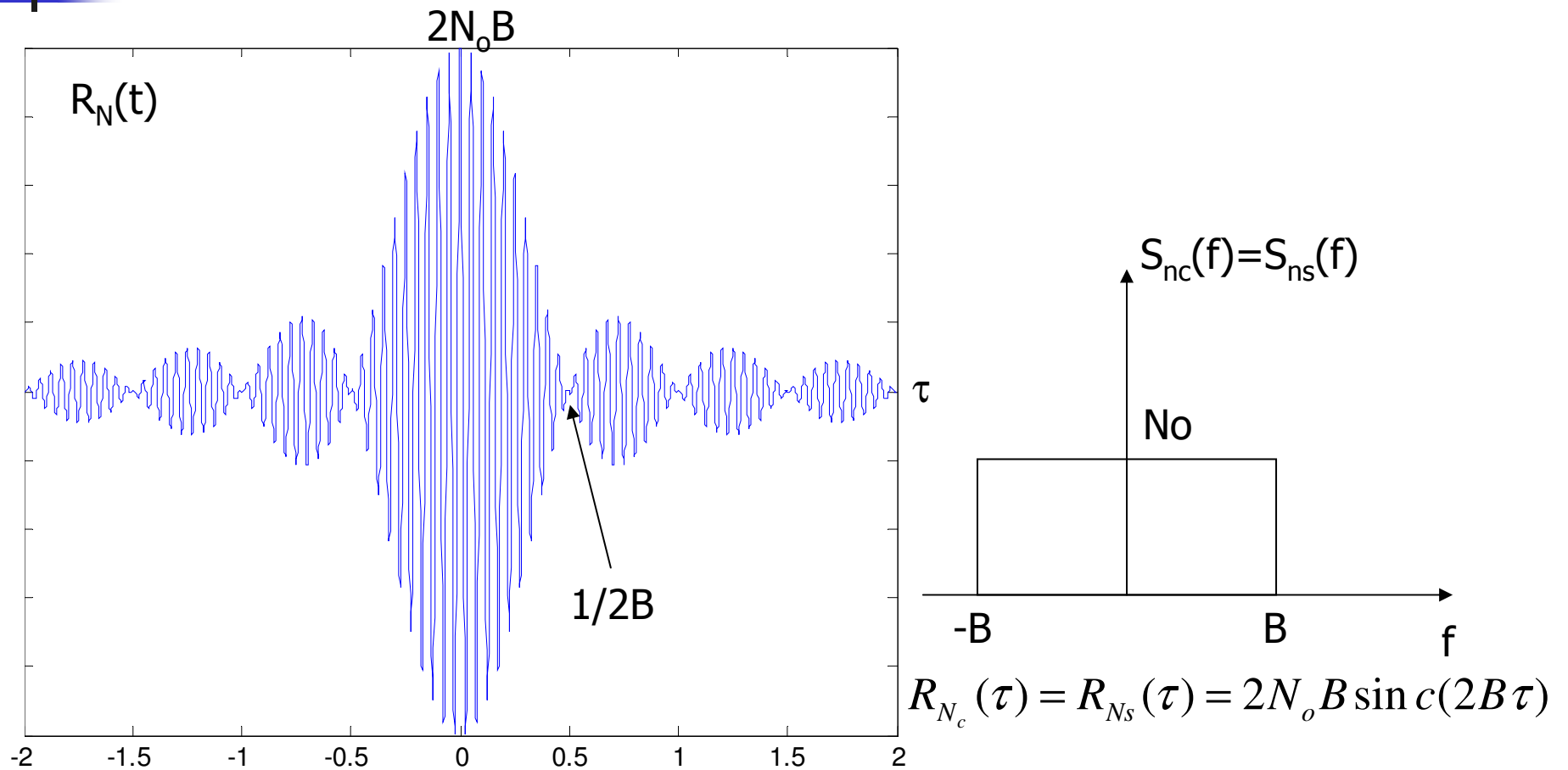
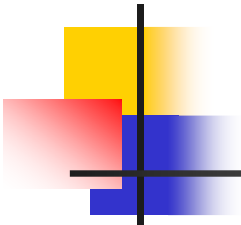

$$R_N(\tau) = 2N_o B \text{sinc}(2B\tau) \cos(2\pi f_c \tau)$$



Communication Systems II

Noise in CW modulation



Noise in CW modulation

- Analysis the effect of noise on the performance of the receiver.
- Analysis of different modulation-demodulation schemes
- Need a criterion to measure the performance
- **Output signal to noise ratio**
 - **Ratio of the average power of the message signal to the average power in the noise, both measured at the receiver output**
 - **Adequate as long as noise and signal are additive at the receiver output**



Assumptions in analysis of noise in CW Modulation

- Noise is
 - Stationary
 - White
 - Gaussian
 - Additive
- We consider
 - DSB-SC, SSB, using coherent demodulation
 - DSB-TC using envelope detector
 - FM

AM Receivers

- The usual AM radio receiver so called superheterodyne type is shown in following figure

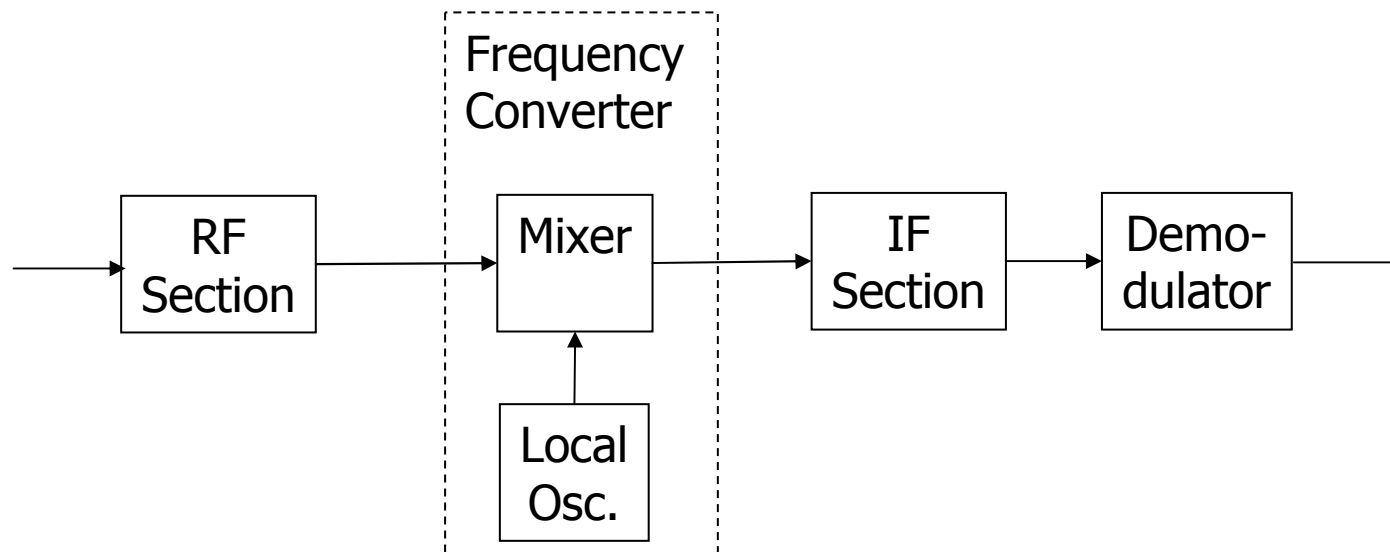

- Typical frequency parameters
 - RF carrier range: 0.535-1.605 MHz
 - Mid band frequency of IF section : 0.455 MHz
 - IF bandwidth: 10 MHz



Superheterodyne AM Receiver

- RF section is tuned to the carrier frequency of interest and amplifies the received signal
- The mixer and local osc. Provides the frequency conversion from the carrier frequency to the IF frequency $F_{IF} = F_{RF} - F_{LO}$
- The output of the IF is applied to a demodulator to recover the transmitted message.

AM Receiver model

- The previous model can be modeled as an equivalent IF filter and demodulator.

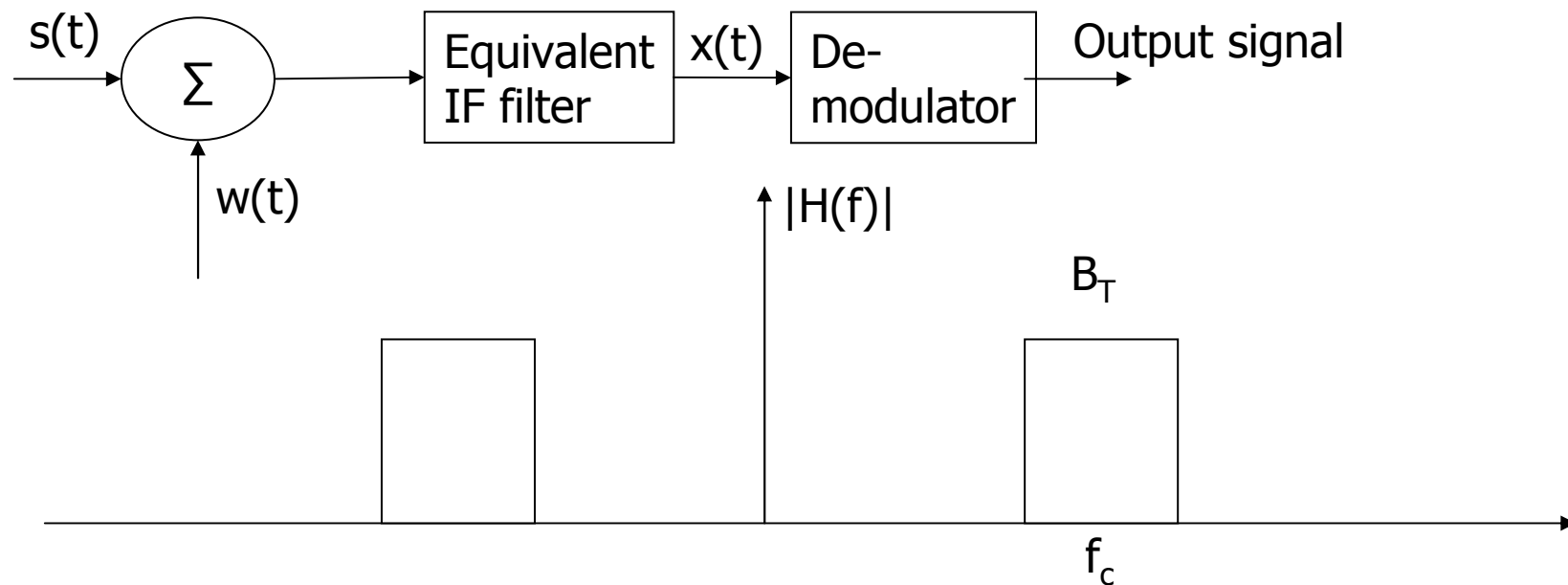

- At the filter input, we have a signal consists of the received modulated signal $s(t)$ and noise $w(t)$ modeled as AWGN with zero mean and PSD of $N_o/2$
- We assume that the IF filter has an ideal BPF response as shown



AM Receiver model

- The composite signal $x(t)$ at the IF filter output is

$$x(t) = s(t) + n(t)$$

- Where $n(t)$ is a band-limited noise with zero mean and PSD

$$S_n(f) = \begin{cases} \frac{N_o}{2} & f_c - \frac{B_T}{2} \leq |f| \leq f_c + \frac{B_T}{2} \\ 0 & \text{otherwise} \end{cases}$$

- $n(t)$ is a narrow band pass noise that can be modeled with $n_c(t)$ and $n_s(t)$



Signal to noise ratio SNR (S/R)

- The SNR can be measured at the output of the receiver as follows

$$(SNR)_o = \frac{\text{Average power of the message signal at the receiver output}}{\text{Average power of noise at the receiver output}}$$

- The SNR requires that noise and signal are additive and this is satisfied by linear receivers as coherent detector.
- SNR depends on the modulation used and the type of receiver.
- This suggest comparative evaluation w.r.t a reference point.
- Reference point is taken to be the input to the receiver from the channel

-

$$(SNR)_c = \frac{\text{Average power of the modulated message signal at the receiver input}}{\text{Average power of noise in message bandwidth at the receiver input}}$$

- We can normalize the performance by dividing the two equations

$$\text{Figure of merit} = \frac{SNR_o}{SNR_c}$$

SNR of BaseBand signal

- $S(t) = m(t) + w(t)$
- After LPF
 - $X(t) = m(t) + n(t)$

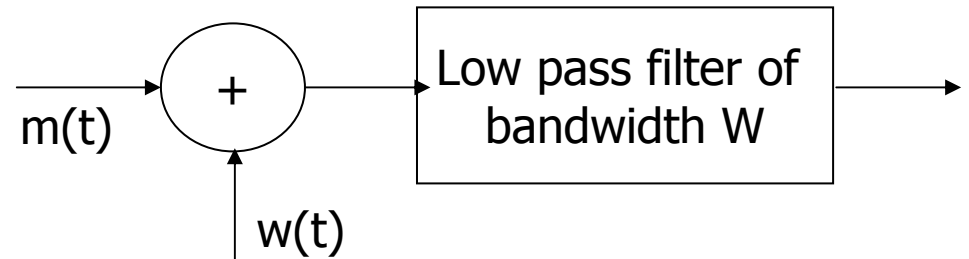

$$SNR_{BB} = \frac{P_T}{\frac{N_o}{2} 2W}$$

P_T Power in the transmitted signal

SNR for Coherent Reception of DSB-SC Modulation

- The IF filter output is multiplied by a local carrier with frequency f_{IF} and then low pass filtering the product

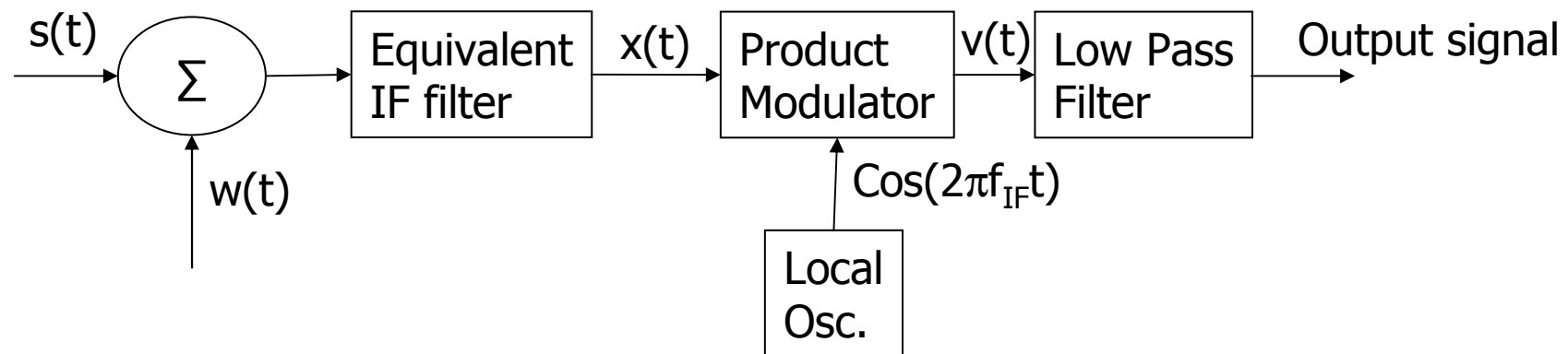

- Consider DSB-SC $s(t) = A_c \cos(2\pi f_c t) m(t)$ where $m(t)$ is considered a sample function of a stationary process of zero mean and PSD $S_M(f)$ limited to maximum frequency W as shown in the next slide

SNR of Coherent Demodulation of DSB-SC

- For a stationary RP, the area under the PSD is equal to the average power of the RP

$$P = \int_{-w}^w S_M(f) df$$

$$R_s(\tau) = E[S(t)S(t+\tau)]$$

$$= A_c^2 E[\cos(2\pi ft) \cos(2\pi f(t+\tau))m(t)m(t+\tau)]$$

$$= \frac{A_c^2}{2} \cos(2\pi f\tau) R_m(\tau)$$

\therefore

$$S_s(f) = \frac{A_c^2}{4} [S_M(f - f_c) + S_M(f + f_c)]$$

- Transmitted BW=2W
- Average power in transmitted signal is $(A_c^2/2)P$

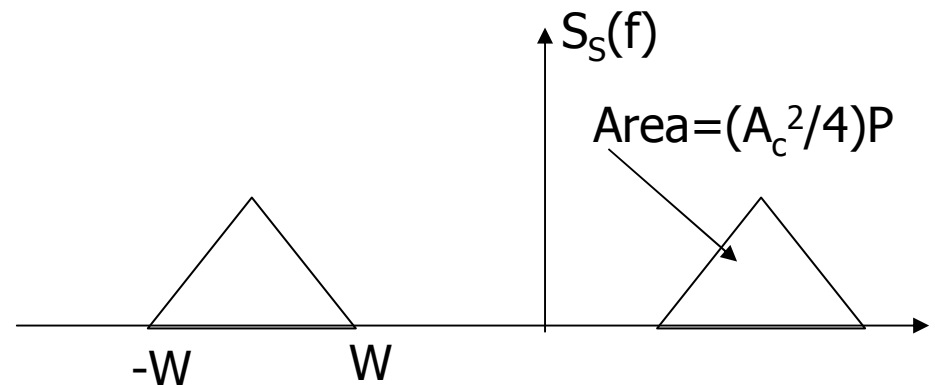
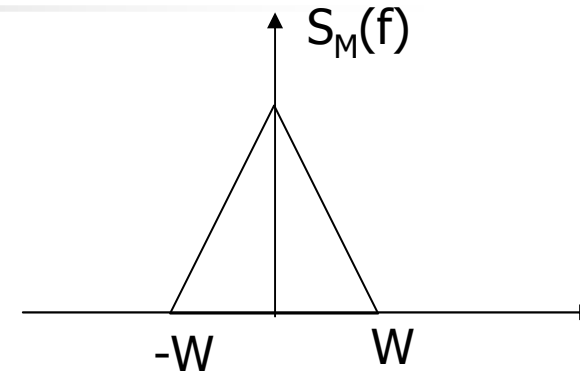



SNR of Coherent Demodulation of DSB-SC

- Noise PSD of $N_o/2$, the average noise power in the message BW W is equal to $2WN_o = 2(N_o/2)(2W)$.

- The SNR_c :

$$SNR_c = \frac{A_c^2 P}{4N_o W}$$

- Next we want to determine the SNR_o using the NBN representation of the filtered noise $n(t)$



SNR of Coherent Demodulation of DSB-SC

- The total signal at the coherent input may be expressed as:

$$x(t) = s(t) + n(t) \\ = A_c \cos(2\pi f_c t) m(t) + n_c \cos(2\pi f_c t) - n_s \sin(2\pi f_c t)$$

- The output of the product modulator

$$v(t) = x(t) \cos(2\pi f_c t) \\ = A_c m(t) \cos(2\pi f_c t) \cos(2\pi f_c t) + n_c(t) \cos(2\pi f_c t) \cos(2\pi f_c t) - n_s(t) \sin(2\pi f_c t) \cos(2\pi f_c t) \\ = \frac{A_c m(t)}{2} + \frac{A_c m(t) \cos(2\pi 2 f_c t)}{2} + \frac{n_c(t)}{2} + \frac{n_c(t) \cos(2\pi 2 f_c t)}{2} - \frac{n_s(t) \sin(2\pi 2 f_c t)}{2}$$

- The output after the LPF $= \frac{A_c m(t)}{2} + \frac{n_c(t)}{2}$



SNR of Coherent Demodulation of DSB-SC

- The output after the LPF $= \frac{A_c m(t)}{2} + \frac{n_c(t)}{2}$
- The output indicates that
 - The message and inphase noise components are additive
 - The quadrature component of the noise is removed
 - The message component at the output is $A_c m(t)/2$
 - The message power at the receiver output is $A_c^2 P/4$
 - The noise component at the receiver output is $n_c(t)/2$
 - PSD of $n_c(t)$ is $S_N(f-f_c) + S_N(f+f_c) = N_0$ for $BW=2W$
 - The average power of noise component is $2WN_0/4$

$$SNR_o = \frac{A_c^2 P}{2WN_0} = \frac{P_T}{WN_0}$$

$$\frac{SNR_o}{SNR_c} = 2, \quad \frac{SNR_o}{SNR_{BB}} = 1$$

SNR for Coherent Reception of DSB-TC Modulation

- The IF filter output is multiplied by a local carrier with frequency f_{IF} and then low pass filtering the product

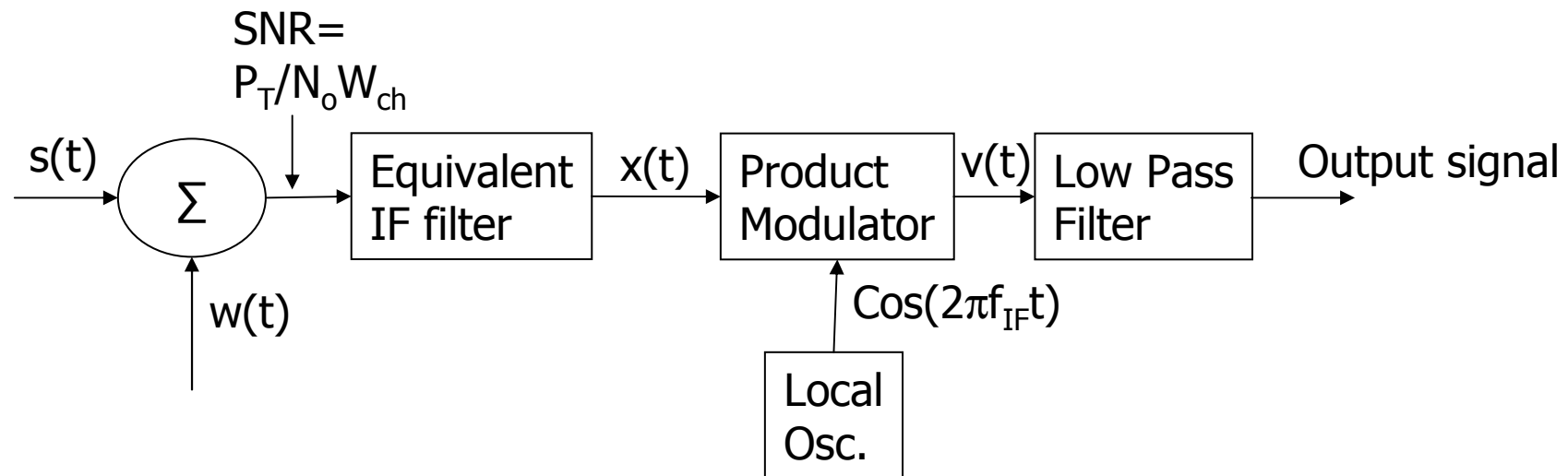

- Consider DSB-TC $s(t) = A_c [1 + k_a m(t)] \cos(2\pi f_c t)$ where $m(t)$ is considered a sample function of a stationary process of zero mean and PSD $S_M(f)$ limited to maximum frequency W as shown in the next slide

SNR of Coherent Demodulation of DSB-TC

- For a stationary RP, the area under the PSD is equal to the average power of the RP

$$P = \int_{-w}^w S_M(f) df$$

$$R_S(\tau) = E[S(t)S(t+\tau)]$$

$$= A_c^2 E[\cos(2\pi ft) \cos(2\pi f(t+\tau))(1+k_a m(t))(1+k_a m(t+\tau))]$$

$$= \frac{A_c^2}{2} \cos(2\pi f\tau) [1+k_a^2 R_m(\tau)]$$

\therefore

$$S_s(f) = \frac{A_c^2 k_a^2}{4} [S_M(f-f_c) + S_M(f+f_c)] + \frac{A_c^2}{4} [\delta(f-f_c) + \delta(f+f_c)]$$

- Transmitted BW=2W
- Average power in transmitted signal is $(A_c^2 K_a^2/2)P + A_c^2/2$

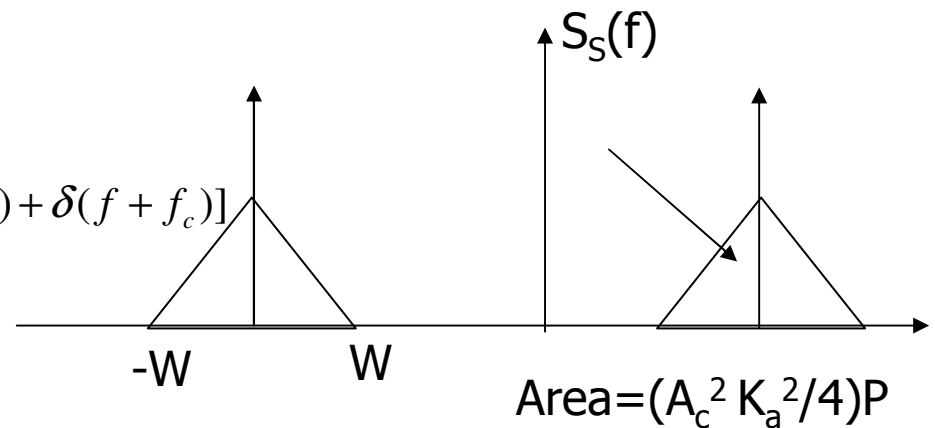
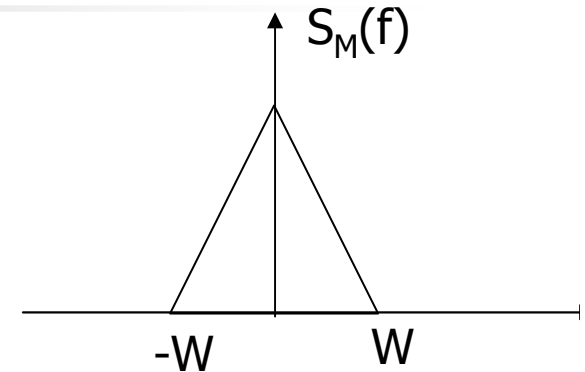



SNR of Coherent Demodulation of DSB-TC

- Noise PSD of $N_o/2$, the average noise power in the message BW W is equal to $2WN_o$.
- The SNR_c :
$$SNR_c = \frac{A_c^2 [1 + K_a^2 P]}{4N_o W}$$
- Next we want to determine the SNR_o using the NBN representation of the filtered noise $n(t)$



SNR of Coherent Demodulation of DSB-TC

- The total signal at the coherent input may be expressed as:

$$x(t) = s(t) + n(t) \\ = A_c [1 + k_a m(t)] \cos(2\pi f_c t) + n_c \cos(2\pi f_c t) - n_s \sin(2\pi f_c t)$$

- The output of the product modulator

$$v(t) = x(t) \cos(2\pi f_c t) \\ = A_c [1 + k_a m(t)] \cos(2\pi f_c t) \cos(2\pi f_c t) + n_c(t) \cos(2\pi f_c t) \cos(2\pi f_c t) - n_s(t) \sin(2\pi f_c t) \cos(2\pi f_c t) \\ = \frac{A_c}{2} + \frac{A_c k_a m(t)}{2} + \frac{A_c [1 + k_a m(t)] \cos(2\pi 2 f_c t)}{2} + \frac{n_c(t)}{2} + \frac{n_c(t) \cos(2\pi 2 f_c t)}{2} - \frac{n_s(t) \sin(2\pi 2 f_c t)}{2}$$

- The output after the LPF = $\frac{A_c}{2} + \frac{A_c k_a m(t)}{2} + \frac{n_c(t)}{2}$

SNR of Coherent Demodulation of DSB-TC

- The output after the LPF and dc block $= \frac{A_c k_a m(t)}{2} + \frac{n_c(t)}{2}$
- The output indicates that
 - The message and inphase noise components are additive
 - The quadrature component of the noise is removed
 - The message component at the output is $A_c k_a m(t)/2$
 - The message power at the receiver output is $(A_c^2/4)(k_a^2 P)$
 - The noise component at the receiver output is $n_c(t)/2$
 - PSD of $n_c(t)$ is $S_N(f-f_c) + S_N(f+f_c) = N_o$ for $BW=2W$
 - The average power of noise component is $2WN_o/4$

$$SNR_o = \frac{A_c^2 (K_a^2 P)}{2WN_o}, P_T = \frac{A_c^2 (1 + K_a^2 P)}{2}$$

$$SNR_o = \frac{(K_a^2 P)}{WN_o} \cdot \frac{P_T}{(1 + K_a^2 P)} = SNR_{BB} \frac{(K_a^2 P)}{(1 + K_a^2 P)}$$

$$\frac{SNR_o}{SNR_c} = \frac{2A_c^2 (K_a^2 P)}{A_c^2 (1 + K_a^2 P)} < 1$$